

*for perfect connections*

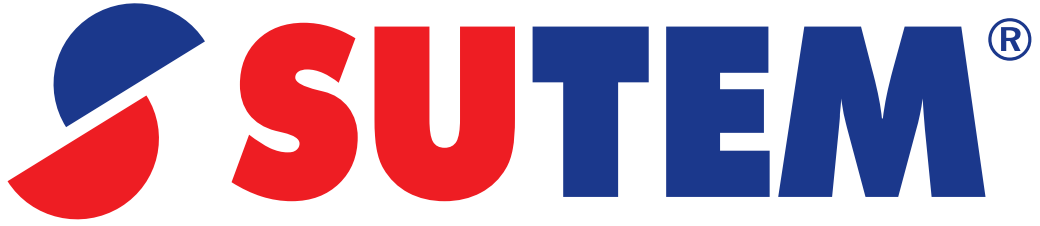

# FIYAT LİSTESİ

## 2023



*for perfect connections*

Sutem Elektrik fiyat listesindeki yazım hatası ve baskı hatalarından dolayı sorumlu değildir.  
Sutem Elektrik fiyat listesinde yayınlanmış olduğumuz teknik özellik ve çizimleri ürün yenileme, değiştirme,  
döviz ve hammadde artışlarından dolayı meydana gelebilecek fiyat artışlarını hiçbir uyarıda bulunmaksızın  
Sutem Elektrik fiyat listesine yansıtma hakkına sahiptir



Günümüzde ki gelişen teknoloji üretim, pazarlama ve satış alanlarında firmaların rekabetlerinin hızlı ve hatasız aynı zamanda da yenilikçi olmalarını zorunlu hale getirmiştir. Bu rekabete ortak olabilmek için tüm firmalar kıyasıya mücadele haline girmiştir ve optimum kalite amacı ile en iyi malzemeyi en iyi fiyata ve tam istenilen zamanda teslim etmek için gerekli olan insan ve teknoloji yatırımlarında bulunmuşlardır.

Bu işlemler için kullanılan bilgisayar destekli otomasyon programlarını, nitelikle insan gücü ile destekleyerek, güler yüzlü hizmet vermek ve müşteri memnuniyeti sağlamak esas amacımız olarak; 2007 yılında İstanbul'da kurulmuş olan şirketimiz sahip olduğu entellektüel bilgilerini sizlere daha iyi hizmet vermek için kullanmakta, hızlı bir şekilde gelişen teknolojinin her daim takipçisi olarak gerekli teknolojik yatırımlarına devam etmektedir.

Sahip olduğumuz güven ve bilgi ile piyasada fark yaratmak ve değerli müşterilerimizin yararına olan tüm yenilikleri sizlere sunmayı görev bilen bizler, güveniniz ve desteğiniz ile geleceğe olan yürüyüşümüzü aynı kararlılıkla devam ettirmekte ve her zaman sizleri yanımızda görmekten mutluluk duymaktayız.



Today's developing technology in the fields of production, marketing and sales is rapidly increasing the competition of companies and error-free and at the same time innovative. To be a part of this competition. For this purpose, all companies have entered into a fierce struggle and use the best material with the aim of optimum quality. The people and technology needed to deliver at the right price and on time have invested.

Computer-aided automation programs used for these processes, with qualified manpower. Our main aim is to provide friendly service and customer satisfaction by supporting; Our company, which was established in Istanbul in 2007, can better provide you with its intellectual knowledge to serve, as a follower of the rapidly developing technology, continues its technological investments.

To make a difference in the market with the trust and knowledge we have and to do all the work for the benefit of our valued customers. We, who take it as our duty to present innovations to you, continue our walk to the future with your trust and support. We continue with the same determination and we are always happy to see you by our side.



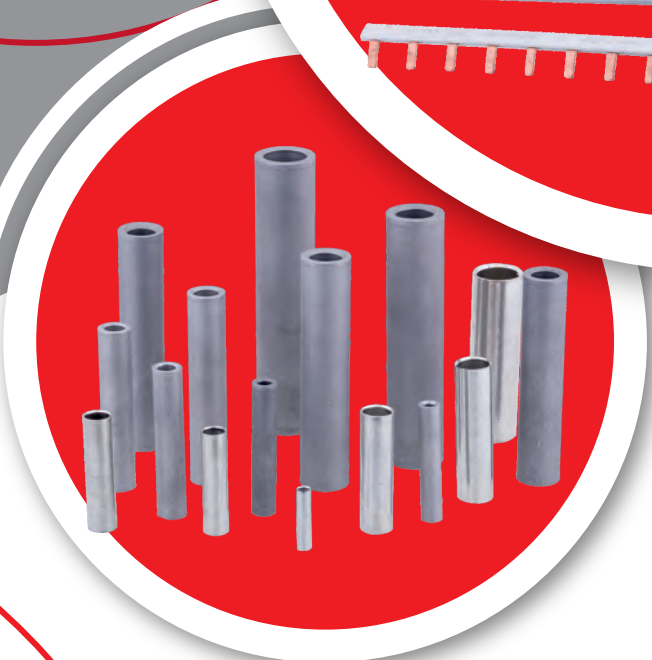
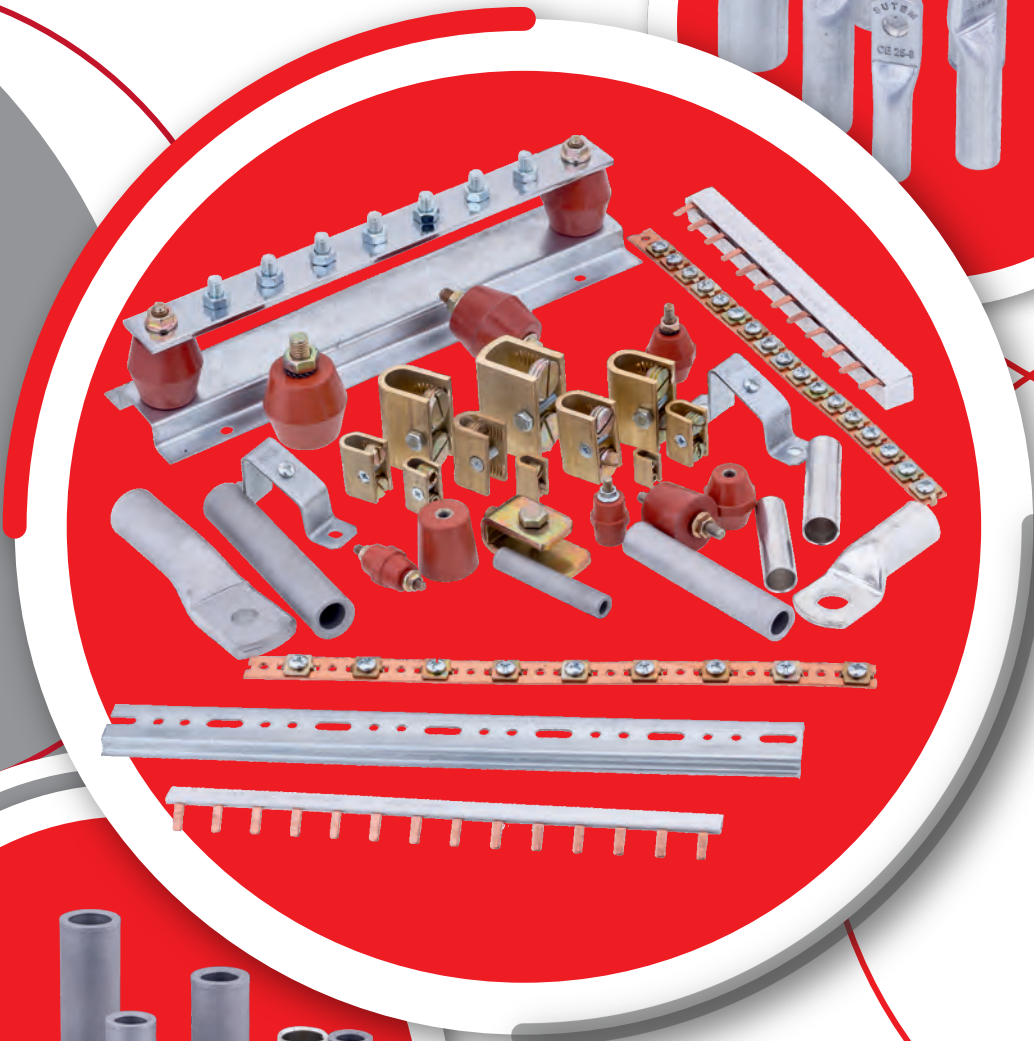



## BAKIR KABLO PABUCLARI EKONOMİK TİP COPPER CABLE LUGS ECONOMIC TYPE

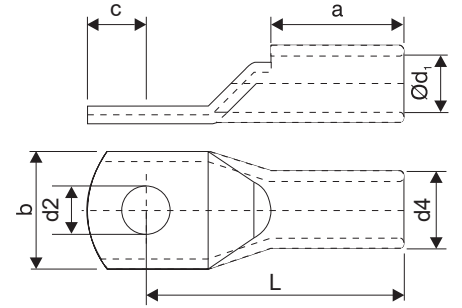

Kod Code	b	d2	L	c	L + c	a	d1	d4	Kutu Adet Box Pieces	Fiyat (Türk Lirası)
STM-16 E	10,5	M 6	24,0	7,5	31,5	12,5	5,7	7,2	500	<b>5,20</b>
STM-16 E	10,5	M 8	24,0	7,5	31,5	12,5	5,7	7,2	500	<b>5,20</b>
STM-25 E	13,0	M 8	31,0	8,5	39,5	17,5	7,0	9,0	350	<b>9,35</b>
STM-35 E	15,5	M 8	34,0	9,5	43,5	17,5	8,5	10,5	200	<b>13,85</b>
STM-50 E	18,0	M 10	40,5	11,0	51,5	21,0	10,0	12,0	150	<b>17,10</b>
STM-70 E	20,5	M 10	44,0	12,0	56,0	24,0	11,5	14,0	100	<b>25,95</b>
STM-95 E	23,5	M 12	48,5	12,5	61,0	25,5	13,5	16,0	75	<b>30,00</b>
STM-120 E	26,5	M 12	55,0	14,0	69,0	30,0	15,5	18,0	50	<b>42,50</b>
STM-150 E	29,5	M 12	61,5	16,5	77,5	37,0	16,5	20,0	40	<b>64,50</b>
STM-185 E	32,5	M 16	67,5	16,5	84,5	41,0	18,5	22,0	30	<b>83,00</b>
STM-240 E	37,0	M 16	76,5	16,5	93,0	45,0	21,5	25,0	25	<b>128,50</b>



## BAKIR KABLO PABUÇLARI STANDART TİP COPPER CABLE LUGS STANDARD TYPE

Gözde yalıtımsız düz boru kablo pabuçları tip tasarımı.  
Soket: DIN EN 13600'e göre bakır yüzey kalay kaplı.  
Sıcaklık aralığı: +120°C'ye kadar.

Popular non-insulated straight tube cable lugs type design.  
Socket: copper according to DIN EN 13600. Surface tin-plated.  
Temperature range: up to +120°C.

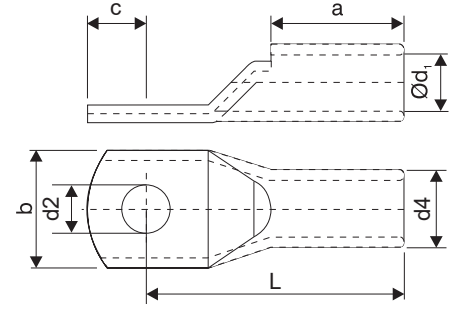

Özel metrik ürünler için lütfen stok bilgisi isteyiniz.  
For special metric products, please request stock information.

Kod Code	b	d2	L	c	L + c	a	d1	d4	Kutu Adet Box Pieces	Fiyat (Türk Lirası)
STM-6 S	8,5	M 5	20,0	6,0	26,0	10,5	4,0	5,5	1000	4,90
STM-10 S	9,0	M 5	22,5	6,5	29,0	12,0	5,0	6,5	800	5,40
STM-10 S	12,5	M 6	22,5	6,5	29,0	12,0	5,0	6,5	800	5,40
STM-10 S	14,0	M 8	22,5	6,5	29,0	12,0	5,0	6,5	800	5,40
STM-16 S	11,0	M 6	26,5	7,5	34,0	15,0	5,5	7,5	500	7,30
STM-16 S	13,5	M 8	26,5	7,5	34,0	15,0	5,5	7,5	500	7,60
STM-16 S	14,5	M 10	26,5	7,5	40,0	15,0	5,5	7,5	500	7,80
STM-25 S	13,5	M 6	30,5	8,5	39,5	17,0	7,0	9,5	350	12,75
STM-25 S	13,5	M 8	30,5	8,5	39,5	17,0	7,0	9,5	350	12,75
STM-25 S	15,5	M 10	30,5	8,5	39,5	17,0	7,0	9,5	350	13,25
STM-35 S	16,0	M 6	36,0	9,5	45,5	19,0	8,5	11,0	200	17,15
STM-35 S	16,0	M 8	36,0	9,5	45,5	19,0	8,5	11,0	200	17,15
STM-35 S	17,0	M 10	36,0	9,5	45,5	19,0	8,5	11,0	200	17,85
STM-35 S	18,0	M 12	36,0	9,5	45,5	19,0	8,5	11,0	200	17,85
STM-50 S	18,5	M 8	40,0	11,5	51,5	20,5	10,0	11,0	150	25,00
STM-50 S	18,5	M 10	40,0	11,5	51,5	20,5	10,0	13,0	150	25,00
STM-50 S	19,0	M 12	40,0	11,5	51,5	20,5	10,0	13,0	150	27,50
STM-50 S	20,5	M 14	40,0	11,5	51,5	20,5	10,0	13,0	150	27,50
STM-70 S	21,0	M 10	44,0	12,0	56,0	24,5	11,5	14,5	100	34,50
STM-70 S	21,0	M 12	44,0	12,0	56,0	24,5	11,5	14,5	100	36,50
STM-70 S	23,0	M 14	44,0	12,0	56,0	24,5	11,5	14,5	100	36,50



## BAKIR KABLO PABUÇLARI STANDART TİP COPPER CABLE LUGS STANDARD TYPE

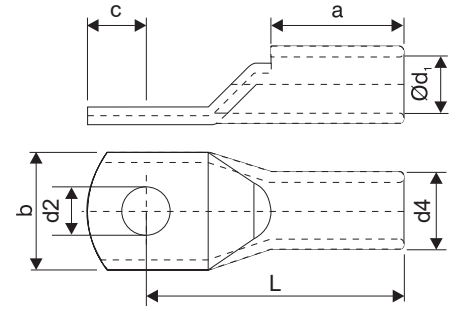

Özel metrik ürünler için lütfen stok bilgisi isteyiniz.  
For special metric products, please request stock information.

Kod Code	b	d2	L	c	L + c	a	d1	d4	Kutu Adet Box Pieces	Fiyat (Türk Lirası)
STM-95 S	24,0	M 10	50,5	12,5	63,0	27,5	13,5	16,5	75	42,00
STM-95 S	24,0	M 12	50,5	12,5	63,0	27,5	13,5	16,5	75	42,00
STM-95 S	24,0	M 14	50,5	12,5	63,0	27,5	13,5	16,5	75	43,00
STM-95 S	24,0	M 16	50,5	12,5	63,0	27,5	13,5	16,5	75	44,00
STM-120 S	26,5	M 10	55,0	14,0	69,0	30,0	15,5	19,0	50	60,00
STM-120 S	26,5	M 12	55,0	14,0	69,0	30,0	15,5	19,0	50	60,00
STM-120 S	26,5	M 14	55,0	14,0	69,0	30,0	15,5	19,0	50	62,00
STM-120 S	26,5	M 16	55,5	14,0	69,0	30,0	15,5	19,0	50	64,00
STM-150 S	30,5	M 12	61,5	16,0	77,5	33,0	16,5	21,0	40	93,00
STM-150 S	30,5	M 14	61,5	16,0	77,5	33,0	16,5	21,0	40	93,00
STM-150 S	30,5	M 16	61,5	16,0	77,5	33,0	16,5	21,0	40	95,00
STM-185 S	33,5	M 10	68,0	16,5	84,5	37,5	18,5	23,0	30	117,00
STM-185 S	33,5	M 12	68,0	16,5	84,5	37,5	18,5	23,0	30	117,00
STM-185 S	33,5	M 14	68,0	16,5	84,5	37,5	18,5	23,0	30	117,00
STM-185 S	33,5	M 16	68,0	16,5	84,5	37,5	18,5	23,0	30	117,00
STM-240 S	38,0	M 10	76,0	17,0	93,0	41,5	21,0	26,0	25	155,00
STM-240 S	38,0	M 12	76,0	17,0	93,0	41,5	21,0	26,0	25	155,00
STM-240 S	38,0	M 14	76,0	17,0	93,0	41,5	21,0	26,0	25	155,00
STM-240 S	38,0	M 16	76,0	17,0	93,0	41,5	21,0	26,0	25	155,00
STM-300 S	41,0	M 16	79,0	18,0	98,0	44,0	23,5	28,5	20	183,00
STM-400 S	48,0	M 16	89,0	25,0	110,0	50,0	27,0	33,0	15	275,00



**BAKIR SIKMALI EK MUFLAR**  
COPPER CLAMP ADDITIONAL MUFS

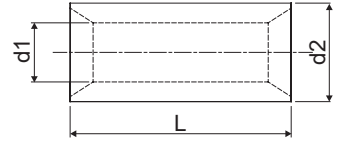

Kod Code	Kesit Cross Section	Açıklama Explanation	L	d1	d2	Kutu Adet Box Pieces	Fiyat (Türk Lirası)
STM SEM-10	10 mm <sup>2</sup>	Sıkmalı Ek Muf (Bakır)	29	5,0	6,5	800	<b>5,50</b>
STM SEM-16	16 mm <sup>2</sup>	Sıkmalı Ek Muf (Bakır)	30	5,6	6,9	500	<b>5,70</b>
STM SEM-25	25 mm <sup>2</sup>	Sıkmalı Ek Muf (Bakır)	39	7,0	8,8	300	<b>9,40</b>
STM SEM-35	35 mm <sup>2</sup>	Sıkmalı Ek Muf (Bakır)	44	8,2	10,0	200	<b>14,00</b>
STM SEM-50	50 mm <sup>2</sup>	Sıkmalı Ek Muf (Bakır)	50	10,2	11,8	150	<b>17,00</b>
STM SEM-70	70 mm <sup>2</sup>	Sıkmalı Ek Muf (Bakır)	55	11,7	13,9	100	<b>26,65</b>
STM SEM-95	95 mm <sup>2</sup>	Sıkmalı Ek Muf (Bakır)	59	16,6	15,6	75	<b>33,00</b>
STM SEM-120	120 mm <sup>2</sup>	Sıkmalı Ek Muf (Bakır)	69	15,5	17,7	50	<b>42,50</b>
STM SEM-150	150 mm <sup>2</sup>	Sıkmalı Ek Muf (Bakır)	76	16,7	19,7	40	<b>67,00</b>
STM SEM-185	185 mm <sup>2</sup>	Sıkmalı Ek Muf (Bakır)	84	18,8	21,90	30	<b>85,50</b>
STM SEM-240	240 mm <sup>2</sup>	Sıkmalı Ek Muf (Bakır)	88	21,2	25,0	25	<b>123,00</b>





## ALÜMİNYUM BAKIR KABLO PABUCU - BI METAL

### ALUMINUM COPPER CABLE LUGS - BI METAL

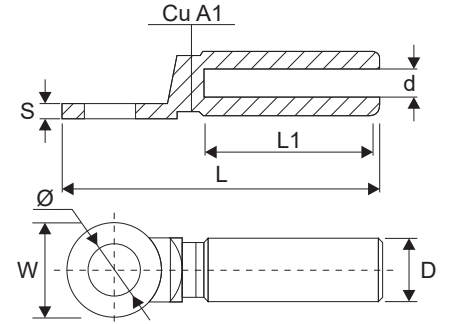

Kod Code	Ø	D	d	L	L1	W	S	Kutu Adet Box Pieces	Fiyat (Dolar)
STM BI-16	11	16	6,0	80	40	20	3,0	20	3,00 \$
STM BI-25	11	16	7,0	80	40	20	3,0	20	3,00 \$
STM BI-35	11	16	8,5	80	40	20	3,0	20	3,00 \$
STM BI-50	13	20	10,0	90	44	24	4,0	20	3,90 \$
STM BI-70	13	20	11,5	90	44	24	4,0	20	3,90 \$
STM BI-95	13	20	13,5	90	44	24	4,0	20	3,90 \$
STM BI-120	13	25	15,0	115	60	30	4,5	10	6,90 \$
STM BI-150	13	25	16,5	115	60	30	4,5	10	6,90 \$
STM BI-185	13	32	18,5	122	60	35	6,0	10	12,00 \$
STM BI-240	13	32	21,0	122	60	35	6,0	10	12,00 \$
STM BI-300	13	34	23,5	128	65	35	6,0	10	13,75 \$
STM BI-400	13	40	26,0	160	95	36	6,0	10	22,50 \$



## ALÜMİNYUM KABLO PABUCU ALUMINUM CABLE LUGS

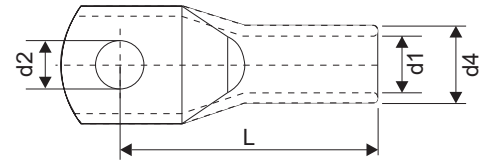

Kod Code	Kesit Cross Section	Açıklama Explanation	L	d1	d2	d4	Kutu Adet Box Pieces	Fiyat (Türk Lirası)
STM ALS-16	16 mm <sup>2</sup>	Kablo Pabucu (Alm.)	0,058	6,0	8,0	10	400	<b>7,65</b>
STM ALS-25	25 mm <sup>2</sup>	Kablo Pabucu (Alm.)	0,066	7,0	8,0	12	300	<b>10,50</b>
STM ALS-35	35 mm <sup>2</sup>	Kablo Pabucu (Alm.)	0,075	8,0	8,0	14	150	<b>16,90</b>
STM ALS-50	50 mm <sup>2</sup>	Kablo Pabucu (Alm.)	0,083	10,0	10,0	16	125	<b>21,50</b>
STM ALS-70	70 mm <sup>2</sup>	Kablo Pabucu (Alm.)	0,097	12,0	12,0	18	100	<b>30,00</b>
STM ALS-95	95 mm <sup>2</sup>	Kablo Pabucu (Alm.)	0,106	13,7	12,0	21	75	<b>42,00</b>
STM ALS-120	120 mm <sup>2</sup>	Kablo Pabucu (Alm.)	0,114	14,0	12,0	22	50	<b>53,00</b>
STM ALS-150	150 mm <sup>2</sup>	Kablo Pabucu (Alm.)	0,116	16,0	12,0	24	40	<b>60,00</b>
STM ALS-185	185 mm <sup>2</sup>	Kablo Pabucu (Alm.)	0,128	17,7	12,0	26	30	<b>77,00</b>
STM ALS-240	240 mm <sup>2</sup>	Kablo Pabucu (Alm.)	0,145	21,0	12,0	30	25	<b>92,00</b>



## ALÜMİNYUM SIKMALI EK MUFLAR

### ALUMINUM CLAMP ADDITIONAL MUFS



Kod Code	Kesit Cross Section	Açıklama Explanation	L	d1	d2	Kutu Adet Box Pieces	Fiyat (Türk Lirası)
STM ALM-16	16 mm <sup>2</sup>	Sıkmalı Ek Muf (Alüminyum)	0,058	10	6,0	400	<b>7,65</b>
STM ALM-25	25 mm <sup>2</sup>	Sıkmalı Ek Muf (Alüminyum)	0,066	12	7,0	250	<b>10,50</b>
STM ALM-35	35 mm <sup>2</sup>	Sıkmalı Ek Muf (Alüminyum)	0,075	14	8,0	150	<b>16,90</b>
STM ALM-50	50 mm <sup>2</sup>	Sıkmalı Ek Muf (Alüminyum)	0,083	16	10,0	125	<b>21,50</b>
STM ALM-70	70 mm <sup>2</sup>	Sıkmalı Ek Muf (Alüminyum)	0,097	18	12,0	100	<b>30,00</b>
STM ALM-95	95 mm <sup>2</sup>	Sıkmalı Ek Muf (Alüminyum)	0,106	21	13,7	75	<b>42,00</b>
STM ALM-120	120 mm <sup>2</sup>	Sıkmalı Ek Muf (Alüminyum)	0,114	22	14,0	50	<b>53,00</b>
STM ALM-150	150 mm <sup>2</sup>	Sıkmalı Ek Muf (Alüminyum)	0,116	24	16,0	40	<b>60,00</b>
STM ALM-185	185 mm <sup>2</sup>	Sıkmalı Ek Muf (Alüminyum)	0,128	26	17,7	30	<b>77,00</b>
STM ALM-240	240 mm <sup>2</sup>	Sıkmalı Ek Muf (Alüminyum)	0,145	30	21,0	25	<b>92,00</b>

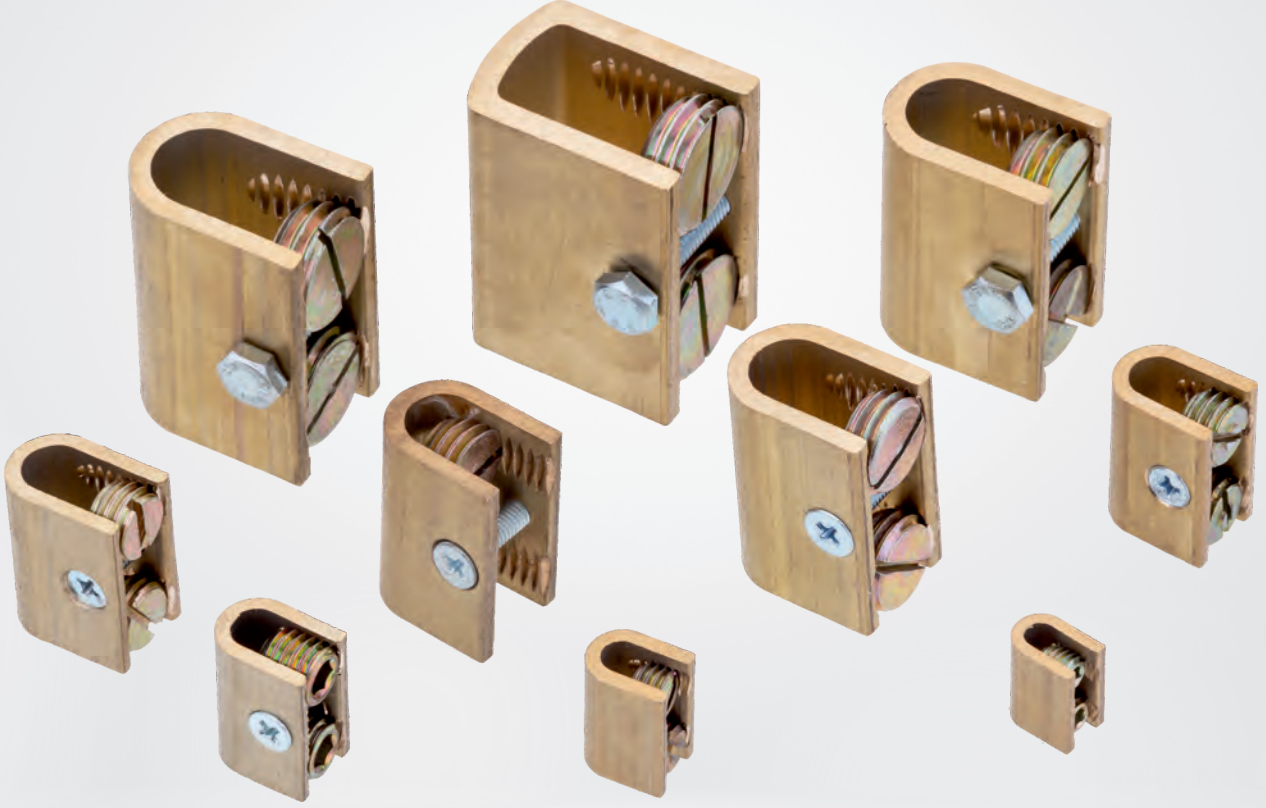

## U KLEMENSLER U TERMINALS

Kod Code	Kesit Cross Section	Açıklama Explanation	Kutu Adet Box Pieces	Fiyat (Türk Lirası)
STM U-6	6 mm <sup>2</sup>	U Klemens (Pirinç)	350	<b>14,20</b>
STM U-10	10 mm <sup>2</sup>	U Klemens (Pirinç)	200	<b>20,95</b>
STM U-16	16 mm <sup>2</sup>	U Klemens (Pirinç)	125	<b>27,90</b>
STM U-25	25 mm <sup>2</sup>	U Klemens (Pirinç)	100	<b>32,00</b>
STM U-35	35 mm <sup>2</sup>	U Klemens (Pirinç)	75	<b>37,90</b>
STM U-50	50 mm <sup>2</sup>	U Klemens (Pirinç)	50	<b>58,00</b>
STM U-70	70 mm <sup>2</sup>	U Klemens (Pirinç)	40	<b>65,00</b>
STM U-95	95 mm <sup>2</sup>	U Klemens (Pirinç)	25	<b>93,00</b>
STM U-120	120 mm <sup>2</sup>	U Klemens (Pirinç)	20	<b>110,00</b>
STM U-150	150 mm <sup>2</sup>	U Klemens (Pirinç)	15	<b>163,00</b>

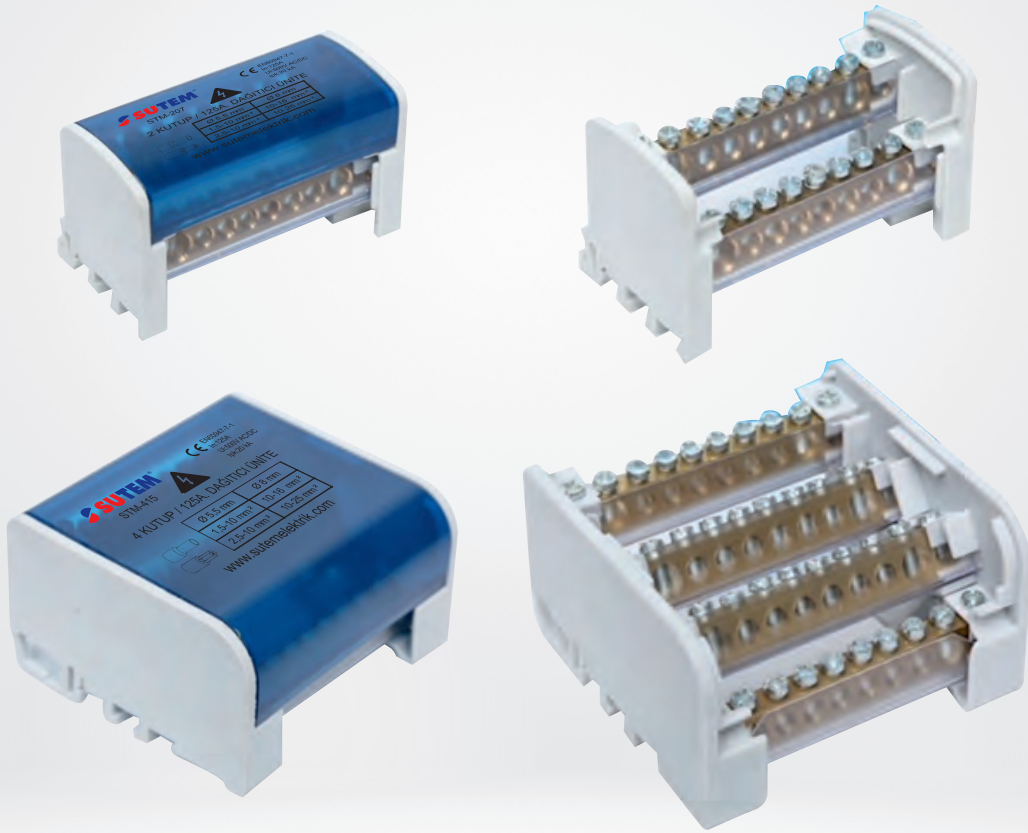

## DAĞITIM ÜNİTESİ DISTRIBUTION UNIT

Kod Code	Açıklama Explanation	Amper	Kutup	Kutu Adet Box Pieces	Fiyat (Türk Lirası)
STM 207	2 x 7 Dağıtım Ünitesi	125A	2	1	<b>120,00</b>
STM 211	2 x 11 Dağıtım Ünitesi	125A	2	1	<b>169,00</b>
STM 215	2 x 15 Dağıtım Ünitesi	125A	2	1	<b>210,00</b>
STM 407	4 x 7 Dağıtım Ünitesi	125A	4	1	<b>210,00</b>
STM 411	4 x 11 Dağıtım Ünitesi	125A	4	1	<b>319,00</b>
STM 415	4 x 15 Dağıtım Ünitesi	125A	4	1	<b>390,00</b>

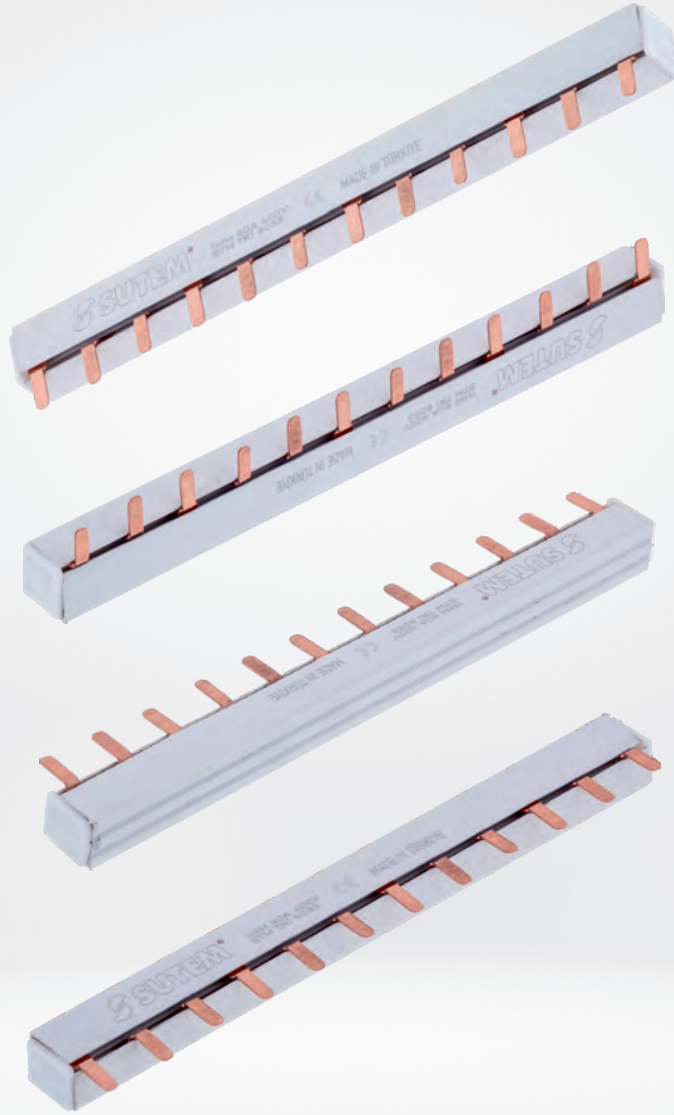

Özel ölçüler için iletişime geçebilirsiniz.  
You can contact for special sizes.

## TRİFAZE W OTOMAT BARASI THREE-PHASE W VENDING BUSBAR

Kod Code	Açıklama Explanation	Amper	Modül	Kutu Adet Box Pieces	Fiyat (Türk Lirası)
STM TRİ-6353	1 mm Elektrolitik Bakır 53 cm	63A	10	25	<b>205,00</b>
STM TRİ-63106	1 mm Elektrolitik Bakır 106 cm	63A	20	25	<b>410,00</b>
STM TRİ-8053	1 mm Elektrolitik Bakır 53 cm	80A	10	25	<b>240,00</b>
STM TRİ-80106	1 mm Elektrolitik Bakır 106 cm	80A	20	25	<b>480,00</b>
STM TRİ-12553	1,5 mm Elektrolitik Bakır 53 cm	125A	10	25	<b>385,00</b>
STM TRİ-125106	1,5 mm Elektrolitik Bakır 106 cm	125A	20	25	<b>770,00</b>
STM TRİ-KPK	Trifaze Bara Yan Kapağı	-	-	500	<b>3,00</b>

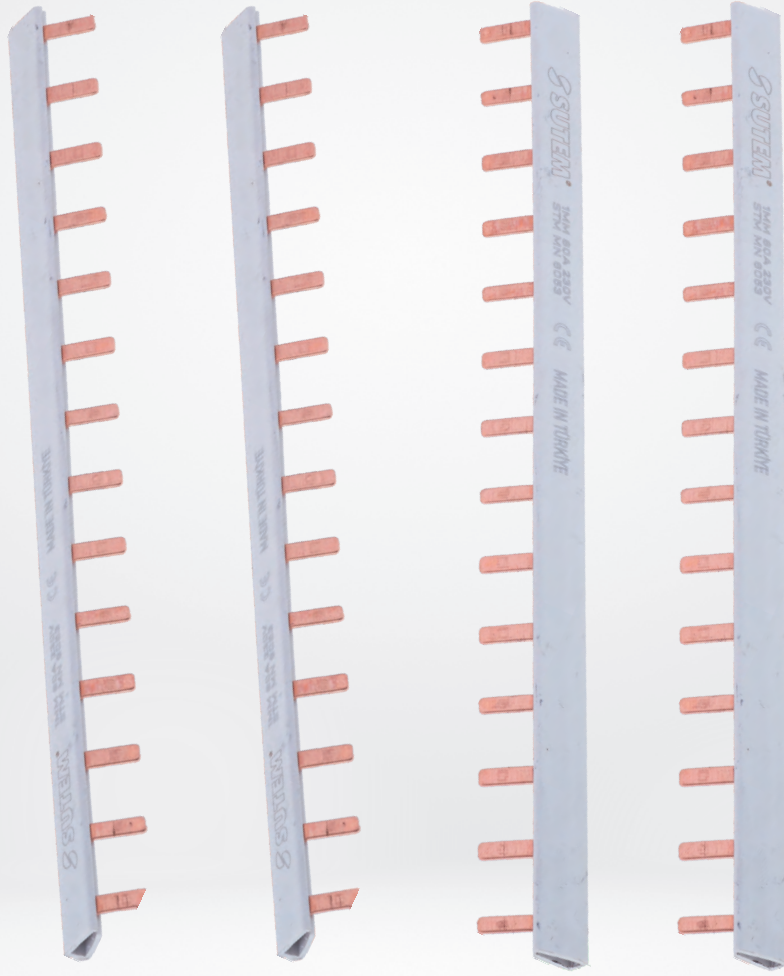

## MONOFAZE W OTOMAT BARASI

### MONOPHAZE W VENDING BUSBAR

Kod Code	Açıklama Explanation	Amper	Modül	Kutu Adet Box Pieces	Fiyat (Türk Lirası)
STM MN-8053	1 mm Elektrolitik Bakır 53 cm	80A	30	50	<b>92,00</b>
STM MN-80106	1 mm Elektrolitik Bakır 106 cm	80A	60	50	<b>184,00</b>
STM MN-12553	1,5 mm Elektrolitik Bakır 53 cm	125A	30	50	<b>155,00</b>
STM MN-125106	1,5 mm Elektrolitik Bakır 106 cm	125A	60	50	<b>310,00</b>

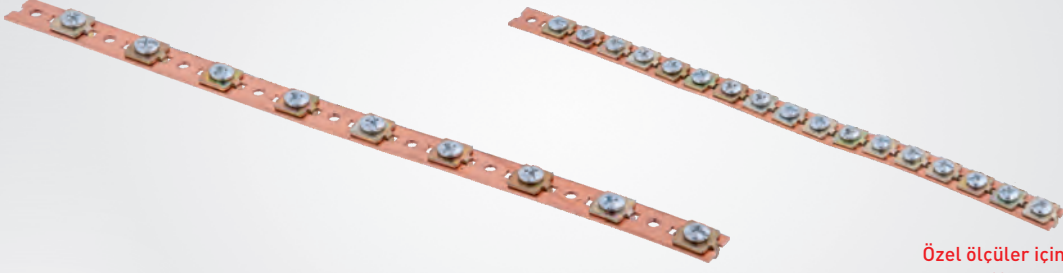

Özel ölçüler için iletişime geçebilirsiniz.  
You can contact for special sizes.

## NÖTR TOPRAKLAMA BARASI NEUTRAL GROUNDING BUSBAR

Kod Code	Açıklama Explanation	Modül	Kutu Adet Box Pieces	Fiyat (Türk Lirası)
STM NTR-1531	15 x 1,5 mm x 1 metre	31	40	320,00
STM NTR-1561	15 x 1,5 mm x 1 metre	61	40	380,00
STM NTR-0231	15 x 2 mm x 1 metre	31	40	350,00
STM NTR-0261	15 x 2 mm x 1 metre	61	40	405,00



## KOMPAKT UZATMA BARASI COMPACT EXTENSION BAR

Kod Code	Açıklama Explanation	Kutup	Modül	Kutu Adet Box Pieces	Fiyat (Türk Lirası)
STM-250-U	Kompakt Uzatma Barası	3	1	1 Takım	460,00
STM-400-U	Kompakt Uzatma Barası	3	1	1 Takım	970,00
STM-600-U	Kompakt Uzatma Barası	3	1	1 Takım	1.410,00





Özel ölçüler için iletişime geçebilirsiniz.  
You can contact for special sizes.

## W OTOMAT RAYI W AUTOMATIC RAIL

Kod Code	Açıklama Explanation	Taban	Uzunluk	Kutu Adet Box Pieces	Fiyat (Türk Lirası)
STM-RAY-DL-030	Delikli Sac Ray	35 x 7,5	30 cm	100	<b>9,00</b>
STM-RAY-DL-1M	Delikli Sac Ray	35 x 7,5	1 m	50	<b>28,00</b>
STM-RAY-DL-2M	Delikli Sac Ray	35 x 7,5	2m	25	<b>56,00</b>
STM-RAY-DZ-030	Düz Sac Ray	35 x 7,5	30 cm	100	<b>9,00</b>
STM-RAY-DZ-1M	Düz Sac Ray	35 x 7,5	1 m	50	<b>28,00</b>
STM-RAY-DZ-2M	Düz Sac Ray	35 x 7,5	2m	25	<b>56,00</b>
STM DRN-1M	Sac Ray	35 x 15	1 m	25	<b>60,00</b>
STM DRN-2M	Sac Ray	35 x 15	2 m	25	<b>120,00</b>
STM 02-12	Sac Ray Taşıyıcı	-	-	100	<b>11,00</b>



**PANO TOPRAKLAMA KLEMENS (AYAKSIZ) 6,5 x 9 mm 80A**  
**PANEL GROUNDING TERMINAL (WITHOUT FEET) 6,5 x 9 mm 80A**

Kod Code	Açıklama Explanation	Kutu Adet Box Pieces	Fiyat (Türk Lirası)
STM 5000	2+4 Delikli Pano Topraklama Klemens	300	<b>27,50</b>
STM 5001	2+5 Delikli Pano Topraklama Klemens	300	<b>31,00</b>
STM 5004	2+8 Delikli Pano Topraklama Klemens	300	<b>36,80</b>
STM 5005	2+10 Delikli Pano Topraklama Klemens	300	<b>38,85</b>
STM 5006	2+13 Delikli Pano Topraklama Klemens	300	<b>47,00</b>
STM 5007	2+18 Delikli Pano Topraklama Klemens	300	<b>63,00</b>
STM 5008	2+23 Delikli Pano Topraklama Klemens	300	<b>80,00</b>
STM 5009	2+28 Delikli Pano Topraklama Klemens	300	<b>115,00</b>

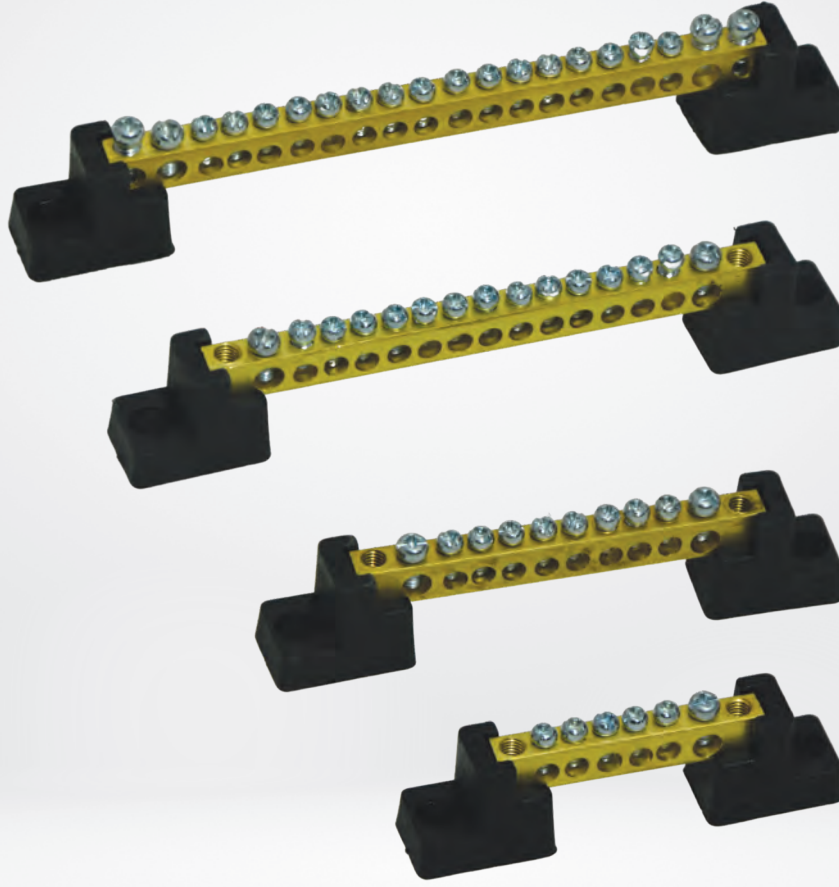

**PANO TOPRAKLAMA KLEMENS (AYAKLI) 6,5 x 9 mm 80A**  
**PANEL GROUNDING TERMINAL (WITH FEET) 6,5 x 9 mm 80A**

Kod Code	Açıklama Explanation	Kutu Adet Box Pieces	Fiyat (Türk Lirası)
STM 5010	2+4 Delikli Pano Topraklama Klemens	150	<b>28,50</b>
STM 5011	2+5 Delikli Pano Topraklama Klemens	150	<b>32,00</b>
STM 5014	2+8 Delikli Pano Topraklama Klemens	150	<b>37,80</b>
STM 5015	2+10 Delikli Pano Topraklama Klemens	150	<b>39,85</b>
STM 5016	2+13 Delikli Pano Topraklama Klemens	150	<b>48,00</b>
STM 5017	2+18 Delikli Pano Topraklama Klemens	150	<b>64,00</b>
STM 5018	2+23 Delikli Pano Topraklama Klemens	150	<b>81,00</b>
STM 5019	2+28 Delikli Pano Topraklama Klemens	150	<b>116,00</b>



### MİNİK FIÇI BOY İZOLATÖR TINY BARREL SIZE INSULATOR

Kod Code	Açıklama Explanation	Kutu Adet Box Pieces	Fiyat (Türk Lirası)
STM M5-2C	İki Tarafı Civatalı	200	<b>12,00</b>
STM M5-2S	İki Tarafı Somunlu	200	<b>13,00</b>
STM M5-1C + 1S	Tek Taraf Somun Tek Taraf Civata	200	<b>14,00</b>



### ORTA BOY KONİK İZOLATÖR MEDIUM SIZE CONICAL INSULATOR

Kod Code	Açıklama Explanation	Kutu Adet Box Pieces	Fiyat (Türk Lirası)
STM M6-2C	İki Tarafı Civatalı	100	<b>16,00</b>
STM M6-2S	İki Tarafı Somunlu	100	<b>17,00</b>
STM M6-1C + 1S	Tek Taraf Somun Tek Taraf Civata	100	<b>18,00</b>



### BÜYÜK BOY FIÇI İZOLATÖR MEDIUM SIZE CONICAL INSULATOR

Kod Code	Açıklama Explanation	Kutu Adet Box Pieces	Fiyat (Türk Lirası)
STM M8-2C	İki Tarafı Civatalı	50	<b>27,00</b>
STM M8-2S	İki Tarafı Somunlu	50	<b>28,00</b>
STM M8-1C + 1S	Tek Taraf Somun Tek Taraf Civata	50	<b>29,00</b>
STM M10-2C	İki Tarafı Civatalı	50	<b>39,00</b>
STM M10-2S	İki Tarafı Somunlu	50	<b>40,50</b>
STM M10-1C + 1S	Tek Taraf Somun Tek Taraf Civata	50	<b>41,50</b>



### TARAK İZOLATÖR COMB INSULATOR

Kod Code	Açıklama Explanation	Kutu Adet Box Pieces	Fiyat (Türk Lirası)
STM 31F	3x1F Tarak İzolatör	60	<b>42,00</b>
STM 32F	3x2F Tarak İzolatör	48	<b>54,00</b>
STM 31FN	3X1F+N Tarak İzolatör	30	<b>56,00</b>
STM 32FN	3X2F+N Tarak İzolatör	30	<b>73,50</b>



## BARA TUTUCU SERFİL BAR HOLDER SERFİL

Kod Code	Açıklama Explanation	Kutu Adet Box Pieces	Fiyat (Türk Lirası)
STM 01-17	Metrik 8 - Metrik 10	50	40,00



## TOPRAKLAMA EŞ POTANSİYEL BARASI 30x3 BAR HOLDER SERFİL

Kod Code	Açıklama Explanation	Kutu Adet Box Pieces	Fiyat (Türk Lirası)
STM 1049	20 cm (M8-5 Civata) 200A	5	300,00
STM 1050	25 cm (M8-6 Civata) 200A	5	365,00
STM 1051	30 cm (M8-7 Civata) 200A	5	420,00
STM 1052	35 cm (M8-8 Civata) 200A	5	520,00

Özel ölçüler için iletişime geçebilirsiniz.  
You can contact for special sizes.



## AL-CU KLEMENSLER (EKO) AL-CU TERMINALS (ECONOMIC)

Kod Code	Açıklama Explanation	Kutu Adet Box Pieces	Fiyat (Türk Lirası)
STM 1060	A25-B16 AL-CU Klemens	100	27,50
STM 1061	A40-B25 AL-CU Klemens	100	33,50
STM 1062	A70-B50 AL-CU Klemens	50	46,50
STM 1063	A120-B70 AL-CU Klemens	50	95,00
STM 1064	A240-B120 AL-CU Klemens	25	230,00



## BRANŞMAN KLEMENSLER (EKO) BRANCH TERMINALS (ECONOMIC)

Kod Code	Açıklama Explanation	Kutu Adet Box Pieces	Fiyat (Türk Lirası)
STM 1070	A25-A25 Branşman Klemens	100	19,00
STM 1071	A40-A40 Branşman Klemens	100	28,50
STM 1072	A70-A70 Branşman Klemens	50	37,50
STM 1073	A120-A120 Branşman Klemens	50	67,50
STM 1074	A240-A240 Branşman Klemens	25	200,00



## STANDART KABLO BAĞLARI STANDARD CABLE TIES

Kod Code	Boyutlar / Dimensions		Renk Color	Bağlama Çapı Tie Diameter	Mukavemeti Strength	Adet Pieces	Fiyat (Türk Lirası)
	En	Boy					
STM-100 M	<b>2,5</b>	100	Siyah-Beyaz	18 mm	8.1 kg	1000	<b>0,170</b>
STM-150 M		150		35 mm		1000	<b>0,260</b>
STM-200 M		200		50 mm		1000	<b>0,370</b>
STM-150 I	<b>3,6</b>	150	Siyah-Beyaz	35 mm	18.0 kg	100	<b>0,415</b>
STM-200 I		200		50 mm		100	<b>0,540</b>
STM-250 I		250		65 mm		100	<b>0,650</b>
STM-300 I		300		76 mm		100	<b>0,835</b>
STM-370 I		370		102 mm		100	<b>1,050</b>
STM-200 ST	<b>4,8</b>	200	Siyah-Beyaz	50 mm	22.0 kg	100	<b>0,690</b>
STM-250 ST		250		60 mm		100	<b>0,890</b>
STM-300 ST		300		76 mm		100	<b>1,070</b>
STM-380 ST		380		105 mm		100	<b>1,530</b>
STM-400 ST		400		115 mm		100	<b>1,680</b>
STM-300 HD	<b>7,6</b>	300	Siyah-Beyaz	76 mm	55.0 kg	100	<b>2,400</b>
STM-380 HD		380		95 mm		100	<b>2,880</b>
STM-450 HD		450		115 mm		100	<b>3,150</b>
STM-550 HD		550		140 mm		100	<b>4,200</b>
STM-750 HD		<b>9,0</b>		750		Siyah-Beyaz	200 mm
STM-950 HD	950		263 mm	100	<b>9,150</b>		



## BASINÇ ŞALTERİ (MONOFAZE) PRESSURE SWITCH (MONOPHASE)

Kod Code	Açıklama Explanation	Kutu Adet Box Pieces	Fiyat (Dolar)
M-BSM6-1/6	1-6 Bar MF Tahliyesiz 1/4"	1	20,00 \$
M-BSM15-1/6	1-6 Bar MF Tahliyesiz 1/2"	1	20,00 \$
M-BSM6-2/11	2-11 Bar MF Tahliyesiz 1/4"	1	22,00 \$
M-BSM15-2/11	2-11 Bar MF Tahliyesiz 1/2"	1	22,00 \$
M-BSM6-5/15	5-15 Bar MF Tahliyesiz 1/4"	1	23,00 \$



## BASINÇ ŞALTERİ (TRİFAZE) PRESSURE SWITCH (THREE-PHASE)

Kod Code	Açıklama Explanation	Kutu Adet Box Pieces	Fiyat (Dolar)
MBTS6-2/8	2-8 Bar TF Tahliyesiz 1/4"	1	24,00 \$
MBTS6-3/11	3-11 Bar TF Tahliyesiz 1/4"	1	24,00 \$
MBTS6-4/16	4-16 Bar TF Tahliyesiz 1/4"	1	24,00 \$
MBTS15-2/8	2-8 Bar TF Tahliyesiz 1/2"	1	24,00 \$
MBTS15-3/11	3-11 Bar TF Tahliyesiz 1/2"	1	24,00 \$
MBTS15-4/16	4-16 Bar TF Tahliyesiz 1/2"	1	24,00 \$



## SIVI SEVİYE FLATÖRLERİ PVC KABLolu LIQUID LEVEL FLOATERS WITH PVC WIRE

Kod Code	Açıklama Explanation	Kutu Adet Box Pieces	Fiyat (Dolar)
M-FT-160	1,60 m Sıvı Seviye Flatörü	1	19,95 \$
M-FT-300	3,00 m Sıvı Seviye Flatörü	1	23,50 \$
M-FT-500	5,00 m Sıvı Seviye Flatörü	1	29,00 \$
M-FT-1000	10,00 m Sıvı Seviye Flatörü	1	45,00 \$
M-FT-1500	15,00 m Sıvı Seviye Flatörü	1	62,00 \$
M-FT-2000	20,00 m Sıvı Seviye Flatörü	1	79,50 \$



**STANDART TEK GİRİŞLİ İZOLELİ KABLO YÜKSÜKLERİ (BAKIR)**  
STANDARD SINGLE ENTRY INSULATED CABLE THREADS (COPPER)

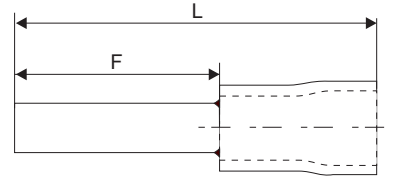

%100 BAKIR PA66

Kod Code	Alman Norm	Fransız Norm	F Boyutlar	L Boyutlar	Kutu Adet Box Pieces	Fiyat (Türk Lirası)
STM-IY-0,50			8	12	1000	<b>0,180</b>
STM-IY-0,75			8	14	1000	<b>0,180</b>
STM-IY-1,0			8	14	1000	<b>0,180</b>
STM-IY-1,5			8	14	1000	<b>0,190</b>
STM-IY-2,5			8	14	500	<b>0,245</b>
STM-IY-4,0			10	17	500	<b>0,420</b>
STM-IY-6,0			12	20	250	<b>0,550</b>
STM-IY-10			12	22	100	<b>0,700</b>
STM-IY-16			12	24	100	<b>1,000</b>
STM-IY-25			16	28	50	<b>1,700</b>
STM-IY-35			16	30	50	<b>2,190</b>
STM-IY-50			20	36	25	<b>4,000</b>
STM-IY-70			20	37	25	<b>7,500</b>



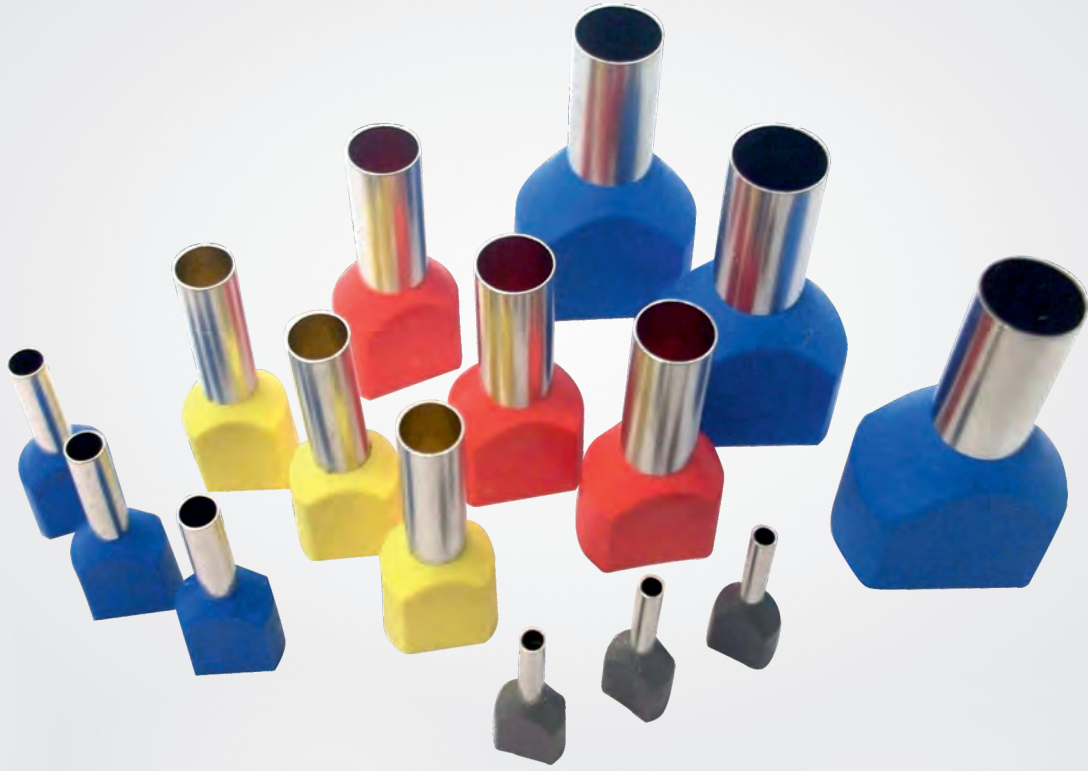





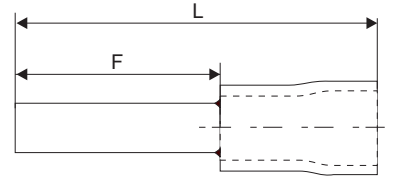





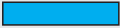





## STANDART ÇİFT GİRİŞLİ İZOLELİ KABLO YÜKSÜKLERİ (BAKIR)

### STANDARD DOUBLE ENTRY INSULATED CABLE THREADS (COPPER)



%100 BAKIR PA66

Kod Code	Alman Norm	Fransız Norm	F Boyutlar	L Boyutlar	Kutu Adet Box Pieces	Fiyat (Türk Lirası)
STM-CY-0,50			8	14	1000	<b>0,325</b>
STM-CY-0,75			8	14	500	<b>0,335</b>
STM-CY-1,0			8	14	500	<b>0,375</b>
STM-CY-1,5			8	14	500	<b>0,435</b>
STM-CY-2,5			10	14	250	<b>0,705</b>
STM-CY-4,0			12	17	200	<b>0,815</b>
STM-CY-6,0			14	20	100	<b>1,050</b>
STM-CY-10			14	27	100	<b>1,680</b>
STM-CY-16			14	31	50	<b>1,930</b>



## YUVARLAK TİP İZOLELİ KABLO PABUCLARI ROUND TYPE INSULATED CABLE LUGS

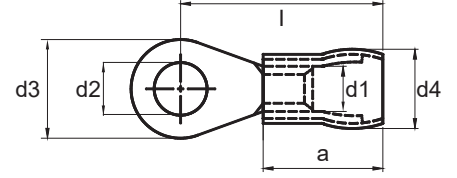

Kod Code	Renk Color	Kablo Kesit Cable Section	Civata Ölçüsü Bolt Size	Boyutlar / Dimensions						Kutu Adet Box Pieces	Fiyat (Türk Lirası)
				d2	d3	l	d1	d4	a		
SYU - 301		0.50 - 1.50 mm <sup>2</sup>	M3	3.2	6.0	16.0	1.6	4.0	10.0	200	0,60
SYU - 401			M4	4.3	8.0	17.0	1.6	4.0	10.0	200	0,85
SYU - 501			M5	5.3	10.0	18.0	1.6	4.0	10.0	200	0,86
SYU - 601			M6	6.5	10.0	18.0	1.6	4.0	10.0	200	1,35
SYU - 801			M8	8.4	14.0	22.0	1.6	4.0	10.0	200	1,38

Kod Code	Renk Color	Kablo Kesit Cable Section	Civata Ölçüsü Bolt Size	Boyutlar / Dimensions						Kutu Adet Box Pieces	Fiyat (Türk Lirası)
				d2	d3	l	d1	d4	a		
SYU - 302		1.50 - 2.50 mm <sup>2</sup>	M3	3.2	6.0	16.0	2.3	4.5	10.0	200	1,05
SYU - 402			M4	4.3	8.0	17.0	2.3	4.5	10.0	200	1,05
SYU - 502			M5	5.3	10.0	19.0	2.3	4.5	10.0	200	1,10
SYU - 602			M6	6.5	11.0	20.0	2.3	4.5	10.0	200	1,50
SYU - 802			M8	8.4	14.0	22.0	2.3	4.5	10.0	200	1,50
SYU - 1002			M10	10.5	15.0	22.0	2.3	4.5	10.0	200	1,60





Kod Code	Renk Color	Kablo Kesit Cable Section	Civata Ölçüsü Bolt Size	Boyutlar / Dimensions						Kutu Adet Box Pieces	Fiyat (Türk Lirası)
				d2	d3	l	d1	d4	a		
SYU - 406		4.00 - 6.00 mm <sup>2</sup>	M4	4.3	8.6	21.0	3.6	6.3	13.0	100	2,20
SYU - 506			M5	5.3	10.0	22.0	3.6	6.3	13.0	100	2,20
SYU - 606			M6	6.5	11.0	22.5	3.6	6.3	13.0	100	2,45
SYU - 806			M8	8.4	14.0	26.0	3.6	6.3	13.0	100	3,20
SYU - 1006			M10	10.5	18.0	28.0	3.6	6.3	13.0	100	3,30
SYU - 1206			M12	13.0	18.0	28.0	3.6	6.3	13.0	100	3,40



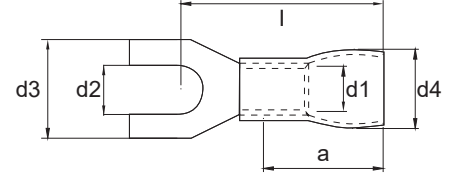



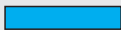

## ÇATAL TİP İZOLELİ KABLO PABUCLARI

### FORK TYPE INSULATED CABLE LUGS

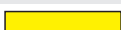

Kod Code	Renk Color	Kablo Kesit Cable Section	Civata Ölçüsü Bolt Size	Boyutlar / Dimensions						Kutu Adet Box Pieces	Fiyat (Türk Lirası)
				d2	d3	l	d1	d4	a		
SÇU - 3001		0.50 - 1.50 mm <sup>2</sup>	M3	3.2	6.0	16.0	1.6	4.0	10.0	200	0,76
SÇU - 4001			M4	4.3	8.0	17.0	1.6	4.0	10.0	200	0,82
SÇU - 5001			M5	5.3	10.0	18.0	1.6	4.0	10.0	200	0,83
SÇU - 6001			M6	6.5	11.0	20.0	1.6	4.0	10.0	200	0,93

Kod Code	Renk Color	Kablo Kesit Cable Section	Civata Ölçüsü Bolt Size	Boyutlar / Dimensions						Kutu Adet Box Pieces	Fiyat (Türk Lirası)
				d2	d3	l	d1	d4	a		
SÇU - 3002		1.50 - 2.50 mm <sup>2</sup>	M3	3.2	5.5	18.0	2.3	4.5	10.0	200	0,85
SÇU - 4002			M4	4.3	6.8	17.0	2.3	4.5	10.0	200	0,88
SÇU - 5002			M5	5.3	10.0	19.0	2.3	4.5	10.0	200	0,90
SÇU - 6002			M6	6.5	11.0	21.0	2.3	4.5	10.0	200	1,22

Kod Code	Renk Color	Kablo Kesit Cable Section	Civata Ölçüsü Bolt Size	Boyutlar / Dimensions						Kutu Adet Box Pieces	Fiyat (Türk Lirası)
				d2	d3	l	d1	d4	a		
SÇU - 4006		4.00 - 6.00 mm <sup>2</sup>	M4	4.3	8.0	21.0	3.6	6.3	13.0	100	1,93
SÇU - 5006			M5	5.3	10.0	22.0	3.6	6.3	13.0	100	1,95
SÇU - 6006			M6	6.5	11.0	23.0	3.6	6.3	13.0	100	2,65
SÇU - 8006			M8	8.4	14.0	26.0	3.6	6.3	13.0	100	2,98

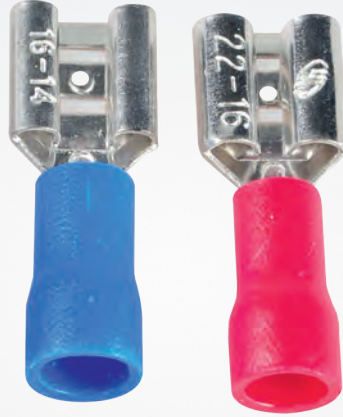

## DİŞİ FASTON TİP İZOLELİ KABLO UÇLARI FEMALE FASTON TYPE INSULATED CABLE ENDS

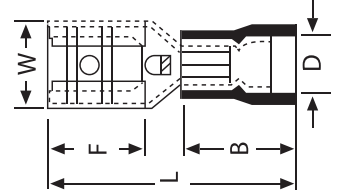

Kod Code	Renk Color	Kablo Kesit Cable Section	Soket Gen. Socket Width	Boyutlar / Dimensions					Kutu Adet Box Pieces	Fiyat (Türk Lirası)
				W	F	L	B	D		
SFD - 1288		<b>0.50 - 1.50 mm<sup>2</sup></b>	0.8 x 2.80	3.2	6.5	19.0	10.5	3.8	200	<b>0,60</b>
SFD - 1488			0.8 x 4.75	5.0	6.4	19.4	10.5	3.8	200	<b>0,70</b>
SFD - 1638			0.8 x 6.35	6.6	7.5	20.8	10.5	3.8	200	<b>0,90</b>

Kod Code	Renk Color	Kablo Kesit Cable Section	Soket Gen. Socket Width	Boyutlar / Dimensions					Kutu Adet Box Pieces	Fiyat (Türk Lirası)
				W	F	L	B	D		
SFD - 2288		<b>1.50 - 2.50 mm<sup>2</sup></b>	0.8 x 2.80	3.2	6.5	19.0	10.5	4.7	200	<b>0,70</b>
SFD - 2488			0.8 x 4.75	5.0	6.4	19.4	10.5	4.7	200	<b>0,80</b>
SFD - 2638			0.8 x 6.35	6.6	7.5	20.8	10.5	4.7	200	<b>0,90</b>



Kod Code	Renk Color	Kablo Kesit Cable Section	Soket Gen. Socket Width	Boyutlar / Dimensions					Kutu Adet Box Pieces	Fiyat (Türk Lirası)
				W	F	L	B	D		
SFD - 5638		<b>4.00 - 6.00 mm<sup>2</sup></b>	0.8 x 6.35	6.6	7.5	24,2	12.5	6.2	100	<b>1,20</b>





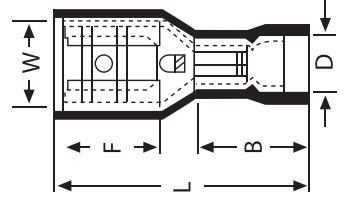

## TAM İZOLELİ DİŞİ FASTON TİP KABLO UÇLARI

### FULLY INSULATED FEMALE FASTON TYPE CABLE ENDS



Kod Code	Renk Color	Kablo Kesit Cable Section	Soket Gen. Socket Width	Boyutlar / Dimensions					Kutu Adet Box Pieces	Fiyat (Türk Lirası)
				W	F	L	B	D		
SFFD - 1288		<b>0.50 - 1.50</b> mm <sup>2</sup>	0.8 x 2.80	3.2	6.5	19.0	10.5	3.8	200	<b>0,85</b>
SFFD - 1488			0.8 x 4.75	5.0	6.4	20.5	10.5	3.8	200	<b>0,95</b>
SFFD - 1638			0.8 x 6.35	6.6	7.5	21.8	10.5	3.8	200	<b>1,30</b>

Kod Code	Renk Color	Kablo Kesit Cable Section	Soket Gen. Socket Width	Boyutlar / Dimensions					Kutu Adet Box Pieces	Fiyat (Türk Lirası)
				W	F	L	B	D		
SFFD - 2288		<b>1.50 - 2.50</b> mm <sup>2</sup>	0.8 x 2.80	3.2	6.5	20.0	10.5	4.7	200	<b>0,95</b>
SFFD - 2488			0.8 x 4.75	5.0	6.4	20.2	10.5	4.7	200	<b>0,98</b>
SFFD - 2638			0.8 x 6.35	6.6	7.5	22.2	10.5	4.7	200	<b>1,25</b>

Kod Code	Renk Color	Kablo Kesit Cable Section	Soket Gen. Socket Width	Boyutlar / Dimensions					Kutu Adet Box Pieces	Fiyat (Türk Lirası)
				W	F	L	B	D		
SFFD - 5638		<b>4.00 - 6.00</b> mm <sup>2</sup>	0.8 x 6.35	6.6	7.5	24,2	12.5	6.2	100	<b>1,35</b>



## ERKEK FASTON TİP TERMİNAL UÇLARI MALE FASTON TYPE TERMINAL TERMINALS

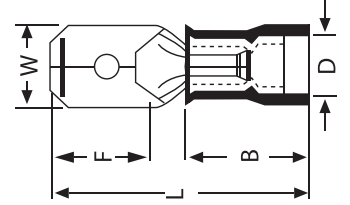

Kod Code	Renk Color	Kablo Kesit Cable Section	Soket Gen. Socket Width	Boyutlar / Dimensions					Kutu Adet Box Pieces	Fiyat (Türk Lirası)
				W	F	L	B	D		
SFE - 1288		<b>0.50 - 1.50 mm<sup>2</sup></b>	0.8 x 2.80	2.8	6.5	19.2	10.5	3.8	200	<b>0,65</b>
SFE - 1488			0.8 x 4.75	4.8	6.7	19.8	10.5	3.8	200	<b>0,65</b>
SFE - 1638			0.8 x 6.35	6.35	6.35	21.8	10.5	3.8	200	<b>0,75</b>

Kod Code	Renk Color	Kablo Kesit Cable Section	Soket Gen. Socket Width	Boyutlar / Dimensions					Kutu Adet Box Pieces	Fiyat (Türk Lirası)
				W	F	L	B	D		
SFE - 2288		<b>1.50 - 2.50 mm<sup>2</sup></b>	0.8 x 2.80	2.8	6.7	19.8	10.5	4.7	200	<b>0,65</b>
SFE - 2488			0.8 x 4.75	4.8	6.7	19.8	10.5	4.7	200	<b>0,65</b>
SFE - 2638			0.8 x 6.35	6.35	7.7	21.8	10.5	4.7	200	<b>0,85</b>

Kod Code	Renk Color	Kablo Kesit Cable Section	Soket Gen. Socket Width	Boyutlar / Dimensions					Kutu Adet Box Pieces	Fiyat (Türk Lirası)
				W	F	L	B	D		
SFE - 5638		<b>4.00 - 6.00 mm<sup>2</sup></b>	0.8 x 6.35	6.6	7.7	24,8	13.0	6.2	200	<b>1,05</b>



## ISI İLE DARALAN SİYAH MAKARONLAR HEAT SHREDDING BLACK PASTA

Kod Code	Ölçü Measurement	Renk Color	Ambalaj (m) / Makara Packaging (m) / Reel	Fiyat (Dolar)
SDM 1,5	1,5	Siyah	200	0,110 \$
SDM 2,0	2,0	Siyah	200	0,130 \$
SDM 2,4	2,4	Siyah	200	0,130 \$
SDM 2,5	2,5	Siyah	200	0,160 \$
SDM 3,0	3,0	Siyah	200	0,175 \$
SDM 3,2	3,2	Siyah	200	0,175 \$
SDM 3,5	3,5	Siyah	200	0,185 \$
SDM 4,0	4,0	Siyah	200	0,215 \$
SDM 4,5	4,5	Siyah	200	0,250 \$
SDM 4,8	4,8	Siyah	200	0,250 \$
SDM 5,0	5,0	Siyah	200	0,270 \$
SDM 6,0	6,0	Siyah	200	0,315 \$
SDM 6,4	6,4	Siyah	200	0,315 \$
SDM 7,0	7,0	Siyah	100	0,375 \$
SDM 8,0	8,0	Siyah	100	0,375 \$
SDM 9,5	9,5	Siyah	100	0,375 \$
SDM 10,0	10,0	Siyah	100	0,420 \$
SDM 12,7	12,7	Siyah	100	0,480 \$
SDM 13,0	13,0	Siyah	100	0,510 \$
SDM 14,0	14,0	Siyah	100	0,610 \$
SDM 16,0	16,0	Siyah	100	0,810 \$
SDM 18,0	18,0	Siyah	100	1,040 \$
SDM 19,1	19,1	Siyah	100	1,040 \$
SDM 20,0	20,0	Siyah	100	1,350 \$
SDM 22,0	22,0	Siyah	100	1,750 \$
SDM 25,4	25,4	Siyah	50	1,900 \$
SDM 30,0	30,0	Siyah	50	2,300 \$
SDM 32,0	32,0	Siyah	50	2,300 \$
SDM 35,0	35,0	Siyah	50	2,900 \$
SDM 38,0	38,0	Siyah	50	3,250 \$
SDM 40,0	40,0	Siyah	50	3,250 \$
SDM 51,0	51,0	Siyah	25	4,100 \$
SDM 60,0	60,0	Siyah	25	5,400 \$
SDM 70,0	70,0	Siyah	25	7,250 \$
SDM 80,0	80,0	Siyah	25	8,130 \$



### 6-16 mm YÜKSÜK SIKMA PENSESİ 6-16 mm SPRING PLIERS

Kod Code	Açıklama Explanation	Kutu Adet Box Pieces	Fiyat (Dolar)
YAC-6	6-16 mm Yüksük Sıkma Pensesi	1	75,00 \$



### 0,8-6 mm YÜKSÜK SIKMA PENSESİ 0,8-6 mm SPRING PLIERS

Kod Code	Açıklama Explanation	Kutu Adet Box Pieces	Fiyat (Dolar)
YAC-8	0,80-6 mm Yüksük Sıkma Pensesi	1	99,00 \$



### 10-120 SKP SIKMA PENSESİ 10-120 SKP CRIMP PLIERS

Kod Code	Açıklama Explanation	Kutu Adet Box Pieces	Fiyat (Dolar)
SKP CK 06	10-120 Skp Sıkma Pensesi	1	180,00 \$



### 10-300 HİDROLİK SKP SIKMA PENSESİ (ÇANTALI SET) 10-300 HYDRAULIC SKP CRIMP PLIERS (SET WITH BAG)

Kod Code	Açıklama Explanation	Kutu Adet Box Pieces	Fiyat (Dolar)
SKP HD 300	10-300 Hidrolik Skp Sıkma Pensesi	1	190,00 \$





## 6-50 MM MEKANİK SKP SIKMA PENSESİ

### 6-50 MM MECHANICAL SKP CRIMPING PLIERS

Kod Code	Açıklama Explanation	Kutu Adet Box Pieces	Fiyat (Dolar)
CK 05	6-50 mm SKP Sıkma Pensesi	1	95,00 \$



## KABLO KESME MAKASI

### CABLE CUTTING SCISSORS

Kod Code	Açıklama Explanation	Kutu Adet Box Pieces	Fiyat (Dolar)
TC 100	Max. 1x150 NYAF 120 mm <sup>2</sup>	1	80,00 \$



## KABLO KESME MAKASI

### CABLE CUTTING SCISSORS

Kod Code	Açıklama Explanation	Kutu Adet Box Pieces	Fiyat (Dolar)
TC 250	Max. 3x70+50 NYY 240 mm <sup>2</sup>	1	150,00 \$



## PANO İÇİ TERMOSTATLAR

### THERMOSTATS IN THE PANEL

Kod Code	Açıklama Explanation	Kutu Adet Box Pieces	Fiyat (Türk Lirası)
STM-26 I	0-60° Pano Isıtma için (Ray Montaj)	10	155,00
STM-26 S	0-10° Pano Soğ. için (Ray Montaj)	10	155,00



## İZOLELİ ELDİVEN INSULATED GLOVES

Kod Code	Açıklama Explanation	Kutu Adet Box Pieces	Fiyat (Euro)
STM 36KV	36 KV İzole Eldiven	1 Çift	190,00 €
STM 40KV	40KV İzole Eldiven	1 Çift	190,00 €



## İZOLELİ ÇIZME & İZOLELİ BARET INSULATED BOOTS & INSULATED HELMET

Kod Code	Açıklama Explanation	Kutu Adet Box Pieces	Fiyat (Türk Lirası)
STM 36KVİÇ	36 KV İzoleli Çizme	1 Çift	Sorunuz
STM İB	İzoleli Baret	1	Sorunuz



## ALÜMİNYUM ÖLÜM TEHLİKE LEVHASI ALUMINUM DEATH HAZARD BOARD

Kod Code	Açıklama Explanation	Kutu Adet Box Pieces	Fiyat (Türk Lirası)
STM ALM	Alüminyum Levha (14x21 cm)	150	34,00

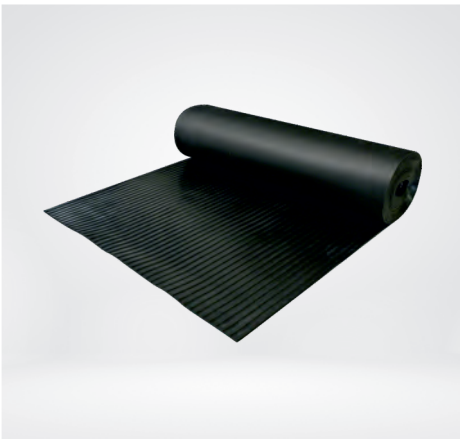

## İZOLE HALILAR INSULATED CARPET

Kod Code	Açıklama Explanation	Kutu Adet Box Pieces	Fiyat (Türk Lirası)
STM IZL 1	1-6 KW - 2mm	1	195,00
STM IZL 15	15 KW - 3 mm	1	300,00
STM IZL 30	30KW - 4 mm	1	400,00
STM IZL 40	40 KW - 5 mm	1	475,00



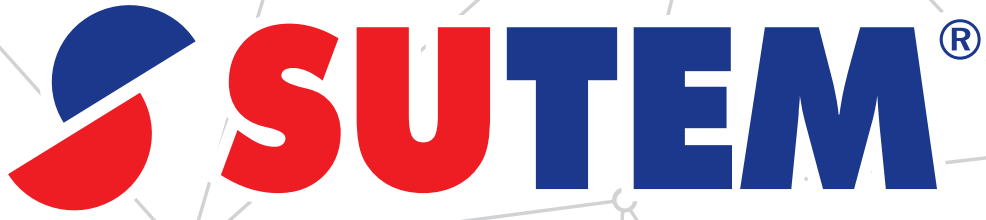

*for perfect connections*



Merkez

Emekyemez Mah. Tenha Sk. No:8/A  
Karaköy / Beyoğlu - İSTANBUL  
Tel.: +90 212 238 54 14

[info@sutemelektrik.com](mailto:info@sutemelektrik.com)



Fabrika

Des Sanayi Sitesi A-12 Blok 108. Sokak No:26  
Dudullu OSB / Ümraniye - İSTANBUL

[fabrika@sutemelektrik.com](mailto:fabrika@sutemelektrik.com)

[www.sutemelektrik.com](http://www.sutemelektrik.com)